

Feed-through header - MSTBV 2,5/ 4-G-5,08 - 1758034

Please be informed that the data shown in this PDF Document is generated from our Online Catalog. Please find the complete data in the user's documentation. Our General Terms of Use for Downloads are valid (<http://phoenixcontact.com/download>)

PCB headers, nominal current: 12 A, number of positions: 4, pitch: 5.08 mm, color: green, contact surface: Tin, mounting: Wave soldering



The figure shows a 10-position version of the product

Your advantages

- ✓ Maximum flexibility when it comes to device design – one header for connectors with different connection technologies
- ✓ Well-known mounting principle allows worldwide use
- ✓ Vertical connection enables multi-row arrangement on the PCB
- ✓ Items that can be aligned in various pitches support flexible and space-saving PCB assembly
- ✓ Easy PCB replacement thanks to plug-in modules



Key Commercial Data

Packing unit	1 pc
GTIN	
GTIN	4017918030247
Weight per Piece (excluding packing)	1.440 g
Custom tariff number	85366930
Country of origin	China

Technical data

Dimensions

Length [l]	8.57 mm
Width	20.32 mm
Pitch	5.08 mm
Dimension a	15.24 mm

Feed-through header - MSTBV 2,5/ 4-G-5,08 - 1758034

Technical data

Dimensions

Width [w]	20.32 mm
Height [h]	15.9 mm
Height	12 mm
Length of the solder pin	3.9 mm
Pin dimensions	1 x 1 mm
Length	8.57 mm

General

Range of articles	MSTBV 2,5/...-G
Insulating material group	I
Rated surge voltage (III/3)	4 kV
Rated surge voltage (III/2)	4 kV
Rated surge voltage (II/2)	4 kV
Rated voltage (III/3)	250 V
Rated voltage (III/2)	320 V
Rated voltage (II/2)	400 V
Connection in acc. with standard	EN-VDE
Nominal current I _N	12 A
Maximum load current	12 A
Insulating material	PA
Flammability rating according to UL 94	V0
Color	green
Number of positions	4

Standards and Regulations

Connection in acc. with standard	EN-VDE
	CSA
Flammability rating according to UL 94	V0

Environmental Product Compliance

China RoHS	Environmentally friendly use period: unlimited = EFUP-e
	No hazardous substances above threshold values

Drawings

Feed-through header - MSTBV 2,5/ 4-G-5,08 - 1758034

Drilling diagram

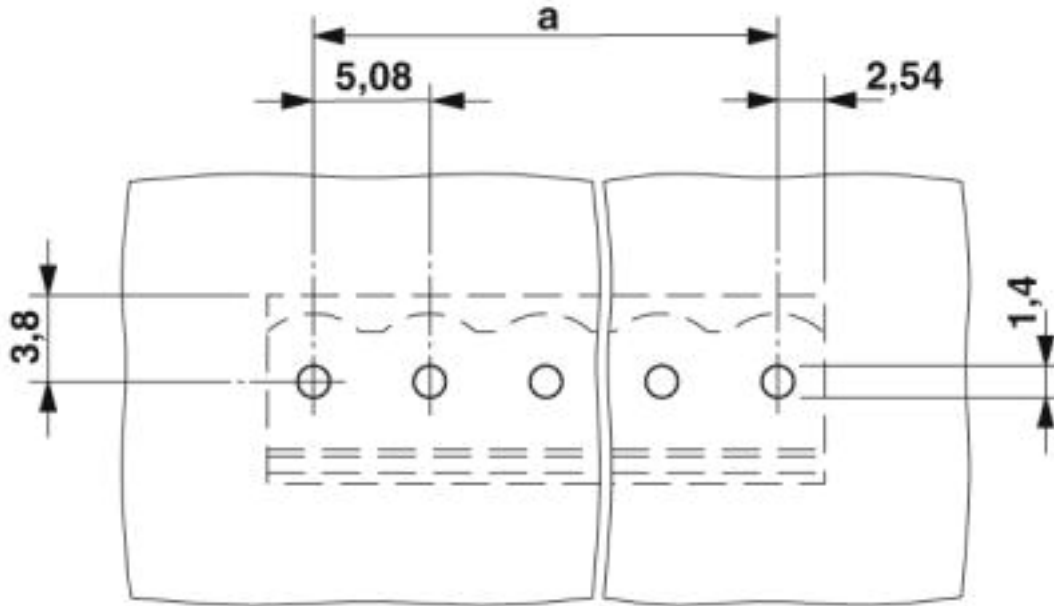

Diagram

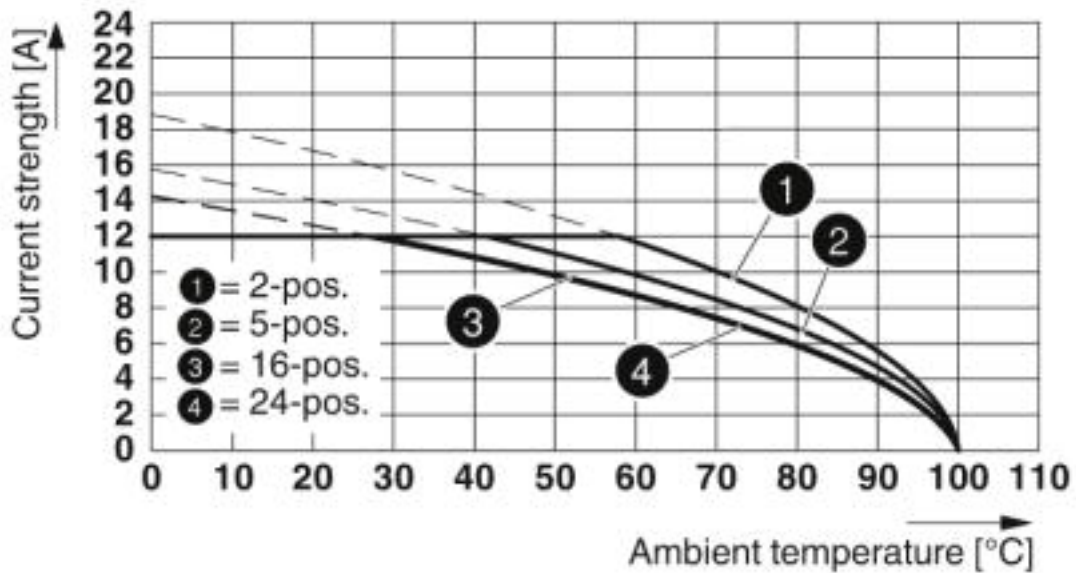

Type: MSTBP 2,5/...-ST-5,08 with MSTBV 2,5/...-G-5,08

Feed-through header - MSTBV 2,5/ 4-G-5,08 - 1758034

Diagram

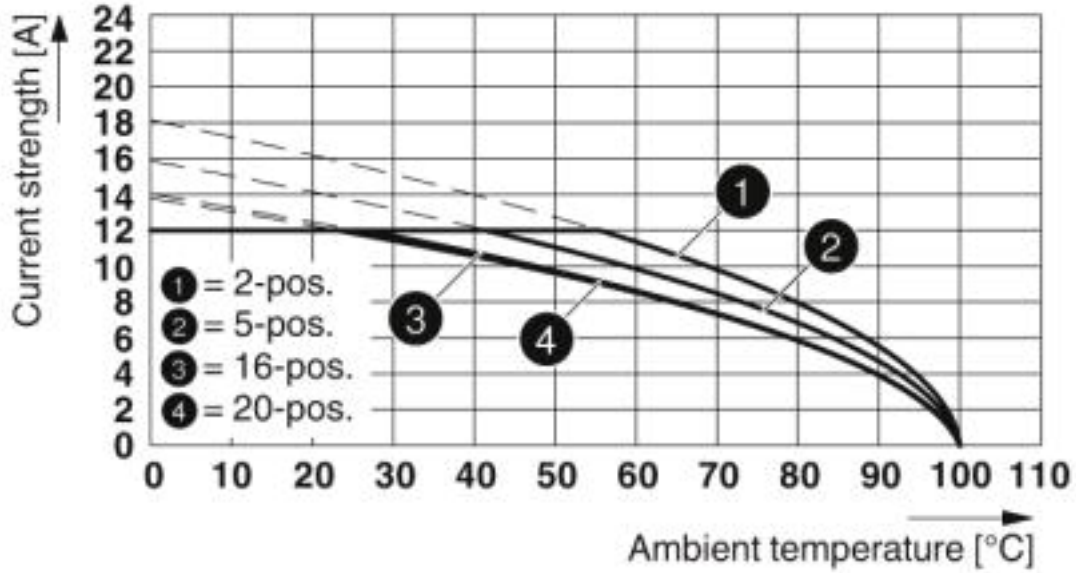

Type: MSTB 2,5/...-ST-5,08 with MSTBV 2,5/...-G-5,08

Diagram

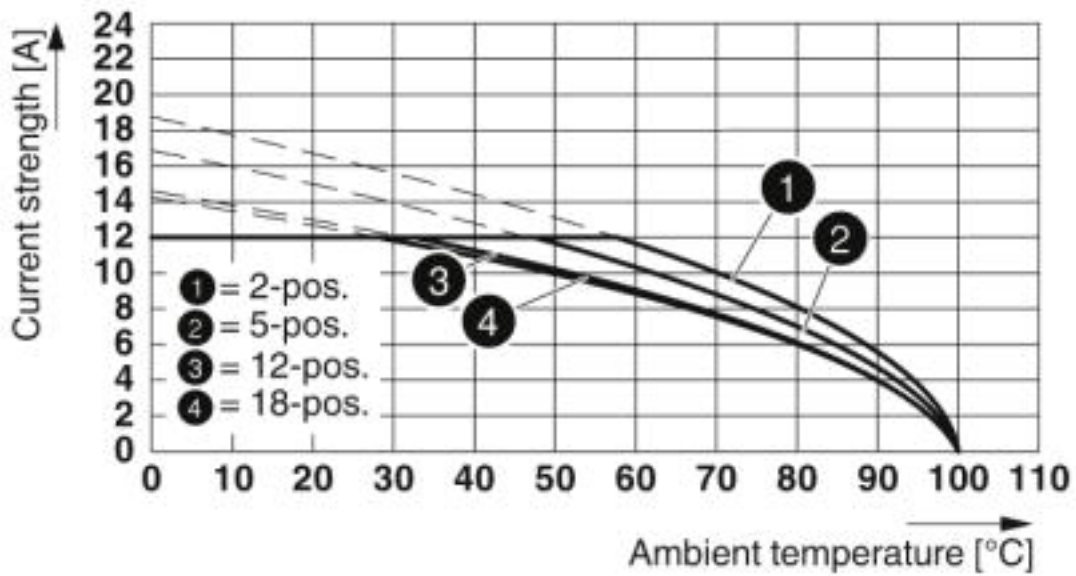

Type: MSTBT 2,5/...-ST-5,08 with MSTBV 2,5/...-G-5,08-5,08

Feed-through header - MSTBV 2,5/ 4-G-5,08 - 1758034

Diagram

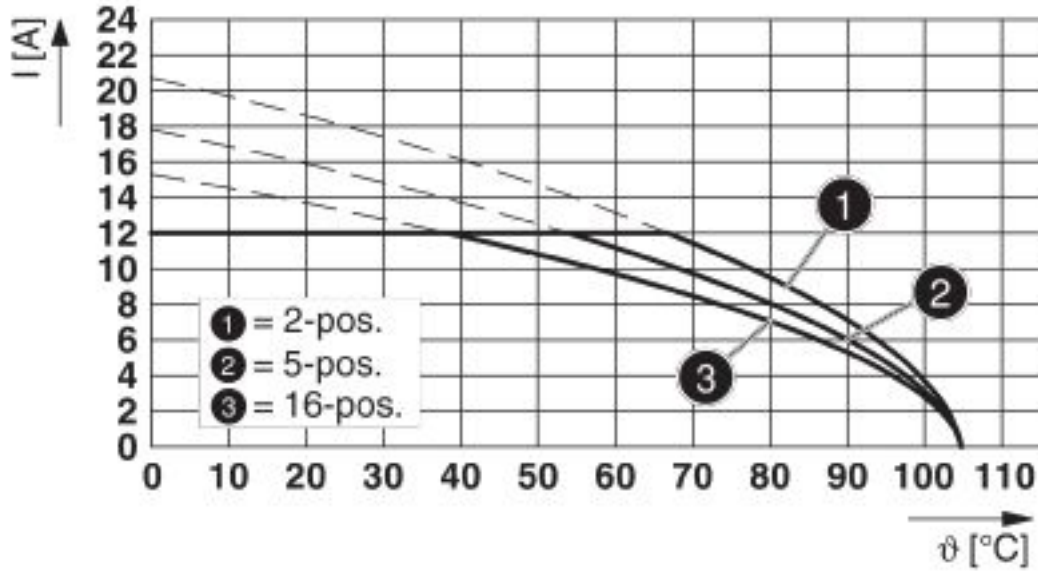

Type: FKCVR 2,5/...-ST-5,08 with MSTBV 2,5/...-G-5,08

Diagram

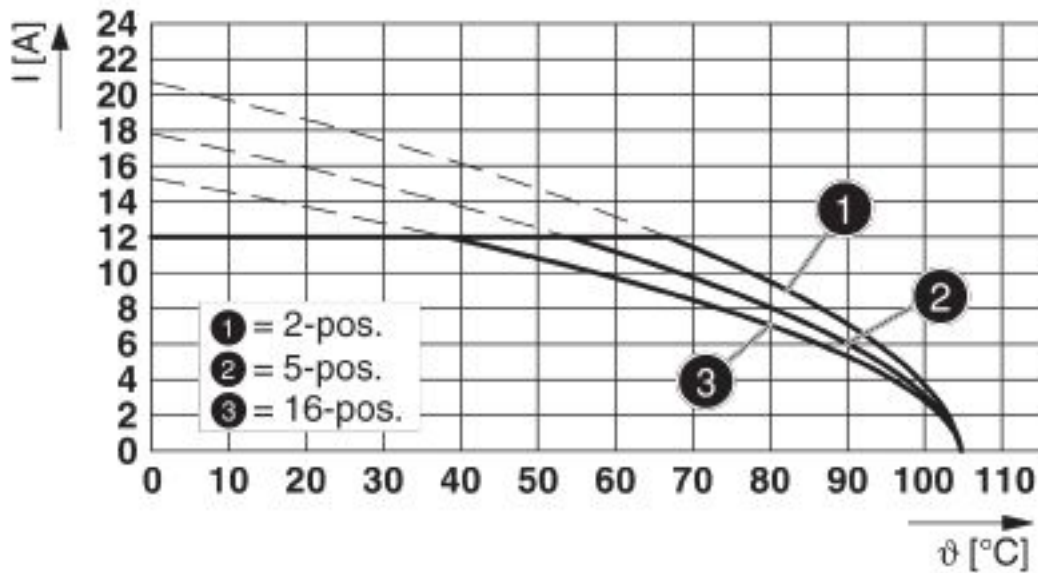

Type: FKCVW 2,5/...-ST-5,08 with MSTBV 2,5/...-G-5,08

Feed-through header - MSTBV 2,5/ 4-G-5,08 - 1758034

Dimensional drawing

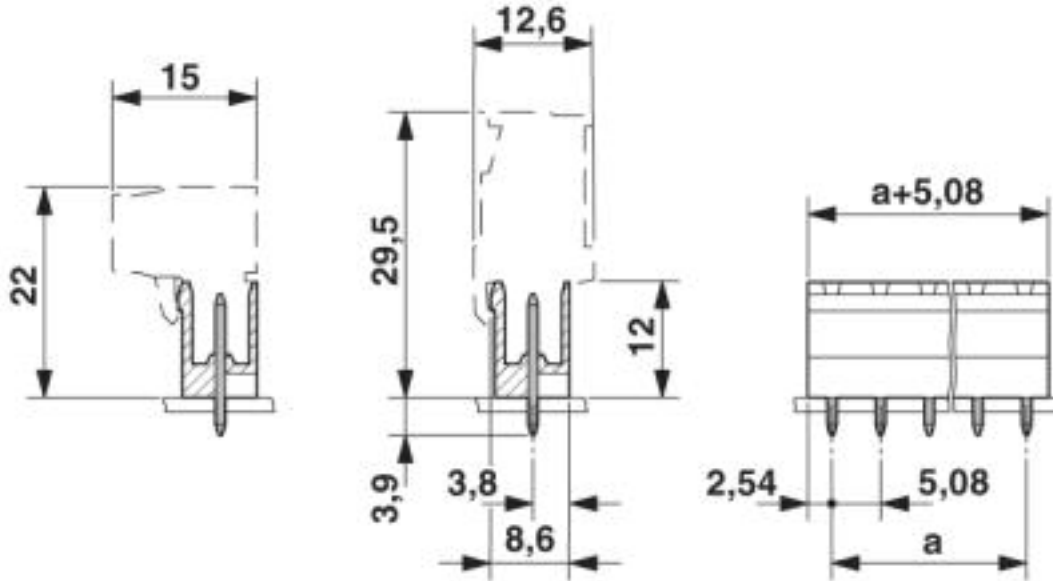

Classifications

eCl@ss

eCl@ss 4.0	27260700
eCl@ss 4.1	27260700
eCl@ss 5.0	27260700
eCl@ss 5.1	27260700
eCl@ss 6.0	27260700
eCl@ss 7.0	27440402
eCl@ss 8.0	27440402
eCl@ss 9.0	27440402

ETIM

ETIM 3.0	EC001121
ETIM 4.0	EC002637
ETIM 5.0	EC002637
ETIM 6.0	EC002637
ETIM 7.0	EC002637

UNSPSC

UNSPSC 6.01	30211810
UNSPSC 7.0901	39121409
UNSPSC 11	39121409

Feed-through header - MSTBV 2,5/ 4-G-5,08 - 1758034

Classifications

UNSPSC

UNSPSC 12.01	39121409
UNSPSC 13.2	39121409

Approvals

Approvals

Approvals

CSA / IECEE CB Scheme / VDE Gutachten mit Fertigungsüberwachung / EAC / cULus Recognized

Ex Approvals

Approval details

CSA		http://www.csagroup.org/services-industries/product-listing/	13631
	B	D	
Nominal voltage UN	300 V	300 V	
Nominal current IN	12 A	10 A	

IECEE CB Scheme		http://www.iecee.org/	DE1-60988-B1B2
Nominal voltage UN	250 V		
Nominal current IN	12 A		

VDE Gutachten mit Fertigungsüberwachung		http://www2.vde.com/de/Institut/Online-Service/VDE-gepruefteProdukte/Seiten/Online-Suche.aspx	40004701
Nominal voltage UN	250 V		
Nominal current IN	12 A		

Feed-through header - MSTBV 2,5/ 4-G-5,08 - 1758034

Approvals

EAC		B.01742
-----	--	---------

cULus Recognized		http://database.ul.com/cgi-bin/XYV/template/LISEXT/1FRAME/index.htm	E60425-19931011
	B	D	
Nominal voltage UN	300 V	300 V	
Nominal current IN	12 A	10 A	

Accessories

Accessories

Coding element

Coding section - CR-MSTB - 1734401



Coding section, inserted into the recess in the header or the inverted plug, red insulating material

Filler plug

Accessories - MSTB-BL - 1755477



Keying cap, for forming sections, plugs onto header pin, green insulating material

Labeled terminal marker

Marker card - SK 5,08/3,8:FORTL.ZAHLEN - 0804293



Marker card, Card, white, labeled, Horizontal: consecutive numbers 1 ... 10, 11 ... 20, etc. up to 91 ... (99)100, mounting type: adhesive, for terminal block width: 5.08 mm, lettering field size: 5.08 x 3.8 mm

Feed-through header - MSTBV 2,5/ 4-G-5,08 - 1758034

Accessories

Marker pen

Marker pen - B-STIFT - 1051993



Marker pen, for manual labeling of unprinted Zack strips, smear-proof and waterproof, line thickness 0.5 mm

Terminal marking

Marker card - SK 5,08/3,8:UNBEDRUCKT - 0805412



Marker card, Card, white, unlabeled, can be labeled with: Marker pen, mounting type: adhesive, for terminal block width: 5.08 mm, lettering field size: 5.08 x 3.8 mm

Additional products

Printed-circuit board connector - TVMSTB 2,5/ 4-ST-5,08 - 1719024



PCB connector, nominal current: 12 A, number of positions: 4, pitch: 5.08 mm, connection method: Screw connection with tension sleeve, color: green, contact surface: Tin

Printed-circuit board connector - FKCN 2,5/ 4-ST-5,08 - 1754584



PCB connector, nominal current: 12 A, number of positions: 4, pitch: 5.08 mm, connection method: Push-in spring connection, color: green, contact surface: Tin

Feed-through header - MSTBV 2,5/ 4-G-5,08 - 1758034

Accessories

Printed-circuit board connector - MSTB 2,5/ 4-ST-5,08 - 1757035

PCB connector, nominal current: 12 A, number of positions: 4, pitch: 5.08 mm, connection method: Screw connection with tension sleeve, color: green, contact surface: Tin



Printed-circuit board connector - MSTBP 2,5/ 4-ST-5,08 - 1769036

PCB connector, nominal current: 12 A, number of positions: 4, pitch: 5.08 mm, connection method: Screw connection with tension sleeve, color: green, contact surface: Tin



Printed-circuit board connector - MSTB 2,5/ 4-STZ-5,08 - 1776155

PCB connector, nominal current: 12 A, number of positions: 4, pitch: 5.08 mm, connection method: Screw connection with tension sleeve, color: green, contact surface: Tin



Printed-circuit board connector - FRONT-MSTB 2,5/ 4-ST-5,08 - 1777303

PCB connector, nominal current: 12 A, number of positions: 4, pitch: 5.08 mm, connection method: Front screw connection, color: green, contact surface: Tin



Printed-circuit board connector - MSTBT 2,5/ 4-ST-5,08 - 1780002

PCB connector, nominal current: 12 A, number of positions: 4, pitch: 5.08 mm, connection method: Screw connection with tension sleeve, color: green, contact surface: Tin



Feed-through header - MSTBV 2,5/ 4-G-5,08 - 1758034

Accessories

Printed-circuit board connector - MVSTBR 2,5/ 4-ST-5,08 - 1792265



PCB connector, nominal current: 12 A, number of positions: 4, pitch: 5.08 mm, connection method: Screw connection with tension sleeve, color: green, contact surface: Tin

Printed-circuit board connector - MVSTBW 2,5/ 4-ST-5,08 - 1792773



PCB connector, nominal current: 12 A, number of positions: 4, pitch: 5.08 mm, connection method: Screw connection with tension sleeve, color: green, contact surface: Tin

Printed-circuit board connector - MSTBC 2,5/ 4-ST-5,08 - 1808832



PCB connector, nominal current: 12 A, number of positions: 4, pitch: 5.08 mm, connection method: Crimp connection, color: green, Corresponding female crimp contacts with current [A] and conductor cross section range [mm²] data: 10A/MSTBC-MT 0,5-1,0 (3190564); 10A/MSTBC-MT 0,5-1,0 BA (3190645); 12A/MSTBC-MT 1,5-2,5 (3190551); 12A/MSTBC-MT 1,5-2,5 BA (3190658). BA = Bandkontakte

Printed-circuit board connector - MSTBC 2,5/ 4-STZ-5,08 - 1809527



PCB connector, nominal current: 12 A, number of positions: 4, pitch: 5.08 mm, connection method: Crimp connection, color: green, Corresponding female crimp contacts with current [A] and conductor cross section range [mm²] data: 10A/MSTBC-MT 0,5-1,0 (3190564); 10A/MSTBC-MT 0,5-1,0 BA (3190645); 12A/MSTBC-MT 1,5-2,5 (3190551); 12A/MSTBC-MT 1,5-2,5 BA (3190658). BA = Bandkontakte

Printed-circuit board connector - MSTBU 2,5/ 4-STD-5,08 - 1824146



Direct plug-in block, nominal current: 12 A, number of positions: 4, pitch: 5.08 mm, connection method: Screw connection with tension sleeve, color: green, contact surface: Tin, mounting: Direct mounting

Feed-through header - MSTBV 2,5/ 4-G-5,08 - 1758034

Accessories

Printed-circuit board connector - MSTBU 2,5/ 4-ST-5,08-FL - 1824379



Direct plug-in block, nominal current: 12 A, number of positions: 4, pitch: 5.08 mm, connection method: Screw connection with tension sleeve, color: green, contact surface: Tin, mounting: Direct mounting

Printed-circuit board connector - SMSTB 2,5/ 4-ST-5,08 - 1826306



PCB connector, nominal current: 12 A, number of positions: 4, pitch: 5.08 mm, connection method: Screw connection with tension sleeve, color: green, contact surface: Tin

Printed-circuit board connector - TMSTBP 2,5/ 4-ST-5,08 - 1853036



PCB connector, nominal current: 12 A, number of positions: 4, pitch: 5.08 mm, connection method: Screw connection with tension sleeve, color: green, contact surface: Tin, The plug allows conductors to be looped through from module to module.

Printed-circuit board connector - FKCVW 2,5/ 4-ST-5,08 - 1873074



PCB connector, nominal current: 12 A, number of positions: 4, pitch: 5.08 mm, connection method: Push-in spring connection, color: green, contact surface: Tin

Printed-circuit board connector - FKCVW 2,5/ 4-ST-5,08 - 1873676



PCB connector, nominal current: 12 A, number of positions: 4, pitch: 5.08 mm, connection method: Push-in spring connection, color: green, contact surface: Tin

Feed-through header - MSTBV 2,5/ 4-G-5,08 - 1758034

Accessories

Printed-circuit board connector - FKCVR 2,5/ 4-ST-5,08 - 1873977

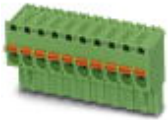

PCB connector, nominal current: 12 A, number of positions: 4, pitch: 5.08 mm, connection method: Push-in spring connection, color: green, contact surface: Tin

Printed-circuit board connector - QC 1/ 4-ST-5,08 - 1883271



PCB connector, nominal current: 10 A, number of positions: 4, pitch: 5.08 mm, connection method: Displacement connection, color: green, contact surface: Tin

Printed-circuit board connector - FKCT 2,5/ 4-ST-5,08 - 1902136



PCB connector, nominal current: 12 A, number of positions: 4, pitch: 5.08 mm, connection method: Push-in spring connection, color: green, contact surface: Tin

Printed-circuit board connector - TFKC 2,5/ 4-ST-5,08 - 1962626



PCB connector, nominal current: 12 A, number of positions: 4, pitch: 5.08 mm, connection method: Push-in spring connection, color: green, contact surface: Tin

Printed-circuit board connector - FKCS 2,5/ 4-ST-5,08 - 1975095



PCB connector, nominal current: 12 A, number of positions: 4, pitch: 5.08 mm, connection method: Push-in spring connection, color: green, contact surface: Tin
